

AMH Series

Dimensions

AMH150C to 550C

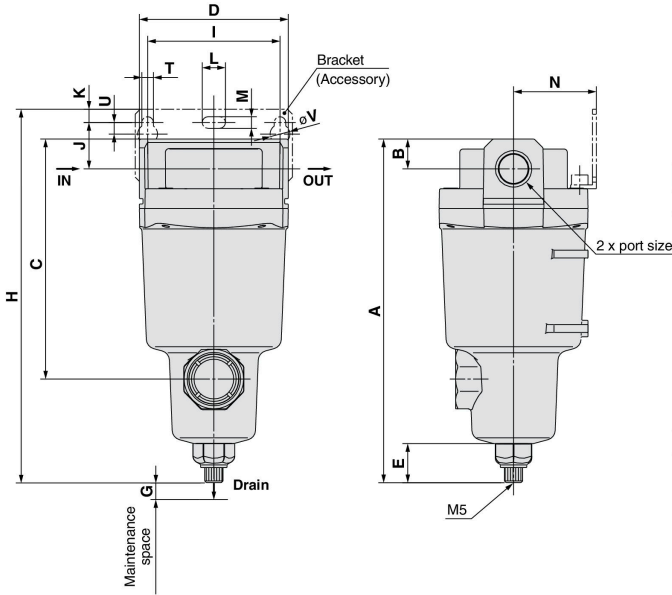
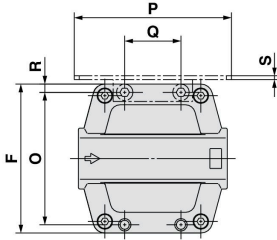

Note) The figure shows the drain cock specification.

Auto drain

C: With auto drain (N.C.)

D: With auto drain (N.O.)

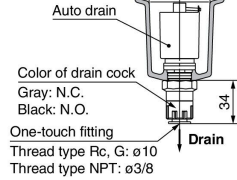

Combination of D: With auto drain (N.O.) and H: For medium air pressure

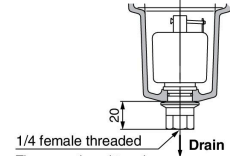

Note) 23 for AMH250C

Option

J: Drain guide 1/4 female threaded

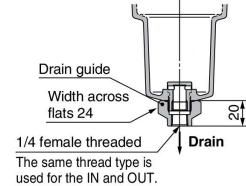

S, U: With differential pressure switch (with indicator)

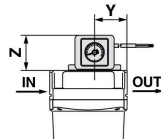

T: With element service indicator

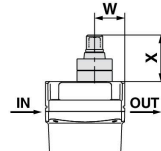

Model	Port size	A	B	C	D	E	F	G	Bracket related dimensions													Element service indicator related dimensions	Differential pressure switch related dimensions			
									H	I	J	K	T	U	L	M	V	N	O	P	Q			R	S	W
AMH150C	1/8, 1/4	161	10	99	63	23	63	10	176	56	20	5	6	12	6	10	35	54	70	26	4.5	1.6	24	37	32	41
AMH250C	1/4, 3/8	175	14	113	76	23	76	10	193	66	24	8	6	12	6	10	40	66	80	28	5	2	27	37	36	41
AMH350C	3/8, 1/2	207	18	145	90	23	90	10	225	80	28	8	7	14	7	12	50	80	95	34	5	2.3	32	37	42	41
AMH450C	1/2, 3/4	228	20	166	106	23	106	10	249	90	31	10	9	18	9	15	55	88	111	50	9	3.2	37	37	43	41
AMH550C	3/4, 1	262	24	200	122	23	122	15	281	100	33	10	9	18	9	15	65	102	126	60	10	3.2	39	37	51	41